

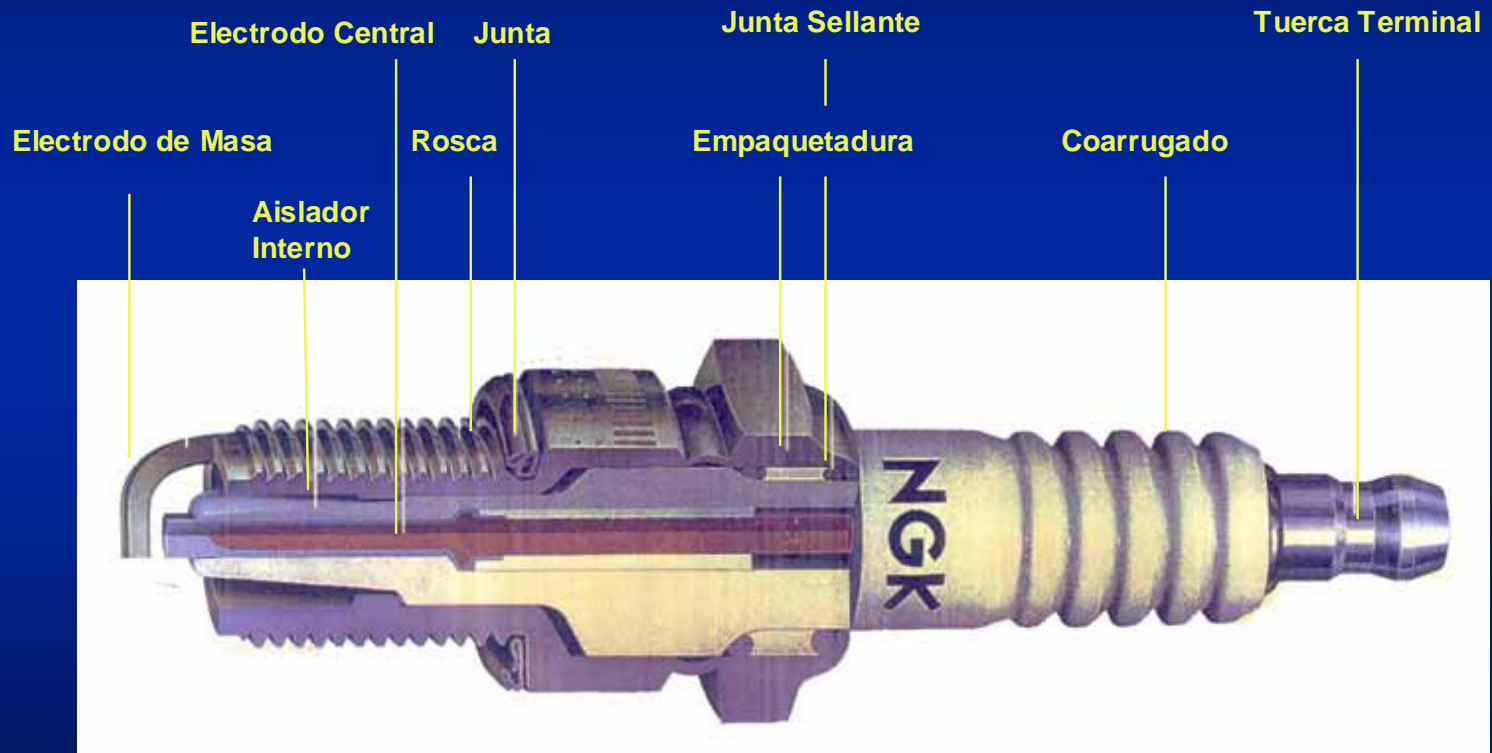

# Bujías de Encendido



# Nomenclatura de una Bujía NGK



# Bujía NGK

## Características Principales

- Unica con núcleo de cobre integral...
- Empaquetadura con cierres en acero...
- Protección anticorrosión de los electrodos...



# Códigos NGK

**B C P R 6 E S - 11**

Diámetro de la rosca		Hexágono en mm	Configuración	Grado Térmico	Longitud de la Rosca	Configuración de la punta de encendido	Galga
A	18mm	25.4	U Descarga Superficial	2 Cal.	<b>B-EF</b> A/Cónico 12,0mm	C E/M Oblícuo	08 0,8mm
B	14mm	20.6	M Tipo Compacto	4	E 19,0mm Rosca Larga	F Asiento Cónico	09 0,9mm
		20.8	Hex. 19mm	5	H 12,7mm Rosca Corta	G Tipo Competición	10 10mm
C	10mm	16.0	L Tipo Corto	6	L 11,2mm	J 2 E/M Diseño Especial	11 11mm
D	12mm	18.0	P Tipo Aislador	7	EH Media Rosca	K <b>2 Electrodos de Masa</b>	13 13mm
E	8mm	13.0	Proyectado	8	Total L= 19mm	T <b>3 Electrodos de Masa</b>	14 14mm
G	PF 1/2	23.8	R <b>Tipo con Resistencia</b>	9	Rosca L= 12,7mm	Q 4 Electrodos de Masa	15 15mm
AB	18mm	20.6	Z Supresor inductivo (Efecto Condensador)	10	Tipo G 22,5mm	M Long. Aislador=14,5mm	20 20mm
		20.8		11	Tipo A 12,0mm	P Tipo Platino	
BC	14mm	16.0		12	Tipo B-F, BM-F 11,2mm	R E/L en Delta	Nada Galga STD
B-F	14mm A/Cón.	16.0		13	Tipo A-F 10,9mm	S <b>Tipo Convencional STD</b>	
DC	12mm	16.0		14 Fria	Tipo C 8,5mm	V E/C de Oro Paladio	
						VX E/C de Platino	
Tipo	BM-F	16.0				W Electrodo de Tungsteno	
Tipo	A-F	20.8				X Con Galga Auxiliar en Serie	
						Y E/C + Proyectado y Corte en V	
<b>BK</b>	<b>BCF</b> (Aislador externo)					A, B, D, Z Diseño Especial	
	— 2,5mm más largo)					-L Grado Térmico Intermedio	
	Ambas son Intercambiables					-LM Longitud del Aislador=14,5mm	
						-N E/M Especial	
						Nada: E/C Corte en V , V-Line	



# Tipos de Bujías



Tipo Standard



Ranurado en V  
Tipo V-Line



Asiento Cónico



2 Electrodo  
de masa



3 Electrodo  
de masa



# Tipos de Bujías



Tipos V y VX  
E/C en Oro Paladio (V)  
y Platino (VX)



Tipo electrodos  
de Platino



Tipo galga  
Proyectada



Tipo Compacto



Tipo rosca 12 mm  
Hex: 16.0 mm



# Tipos de Bujías



Tipo rosca 12 mm  
Hex: 18.0 mm



Tipo rosca 10 mm



Tipo rosca 8 mm



Tipo Competición



Tipo Competición  
Descarga de Superficie



# Rango térmico y trayectoria del flujo de calor en las bujías.



Mayor superficie

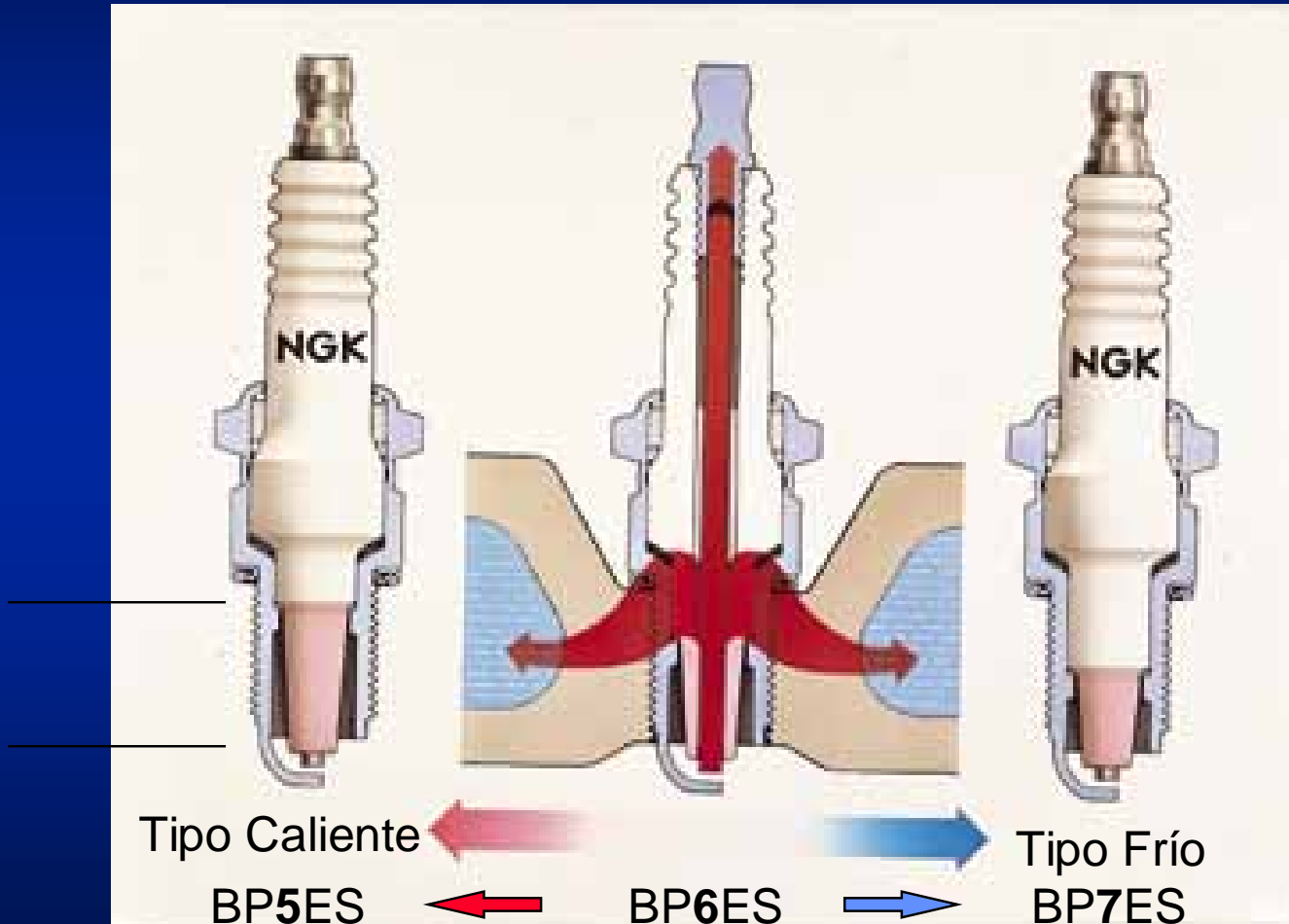



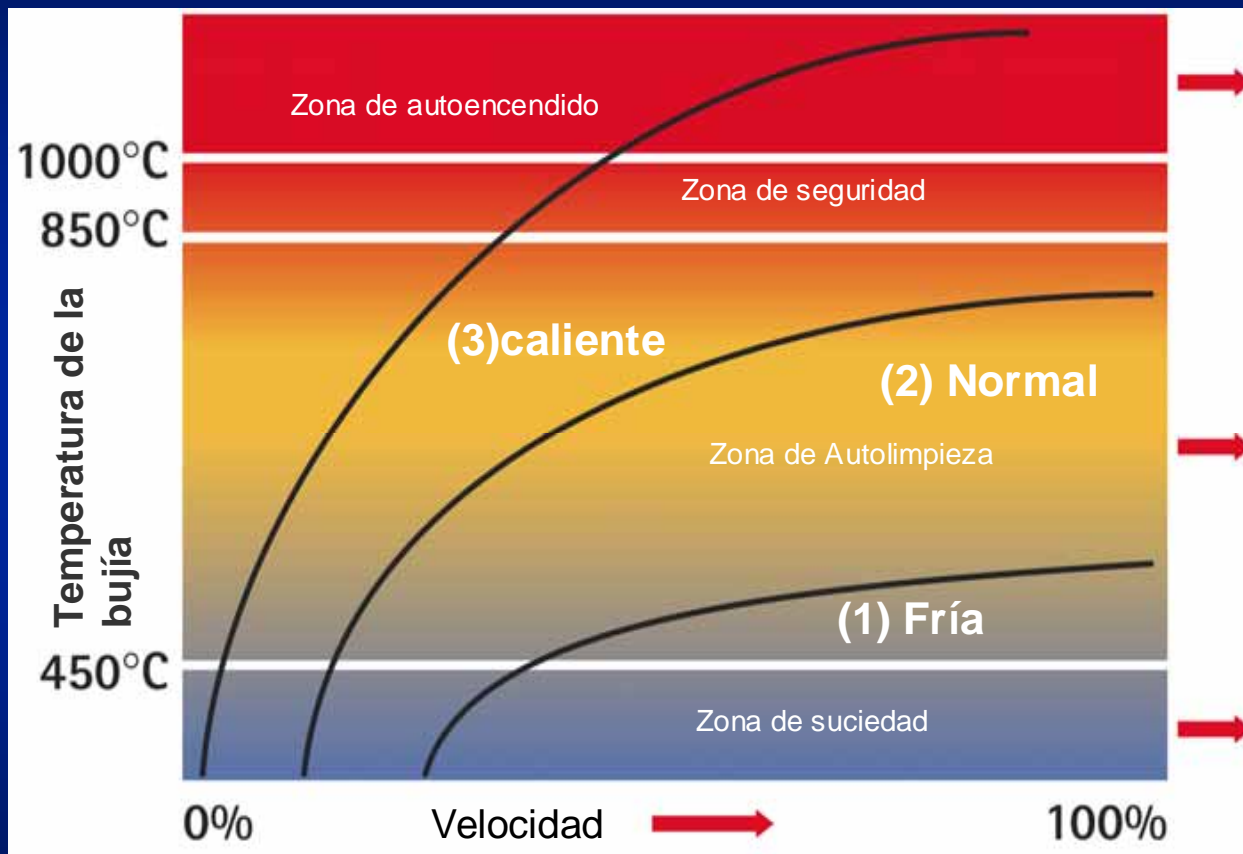

**(3) caliente**



**(2) Normal**



**(1) Fría**



# Funcionamiento Normal



La corriente eléctrica salta del electrodo central al de masa, provocando así la chispa.

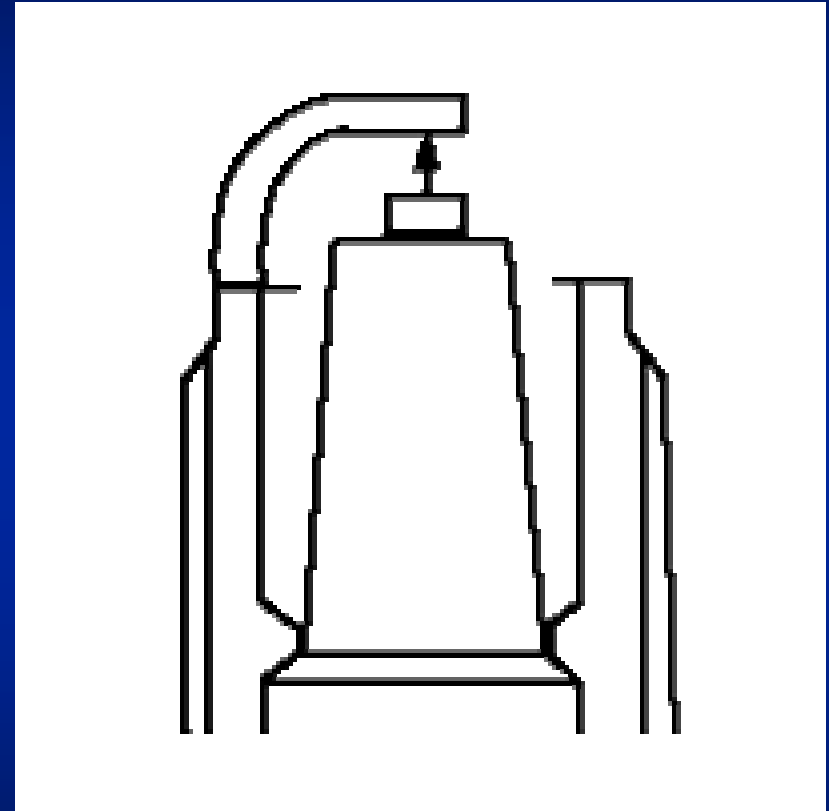

# Bujía Comunicada

Debido a la acumulación de impurezas, la corriente tiende a desplazarse por la superficie del aislador interno, evitando así que salte la chispa

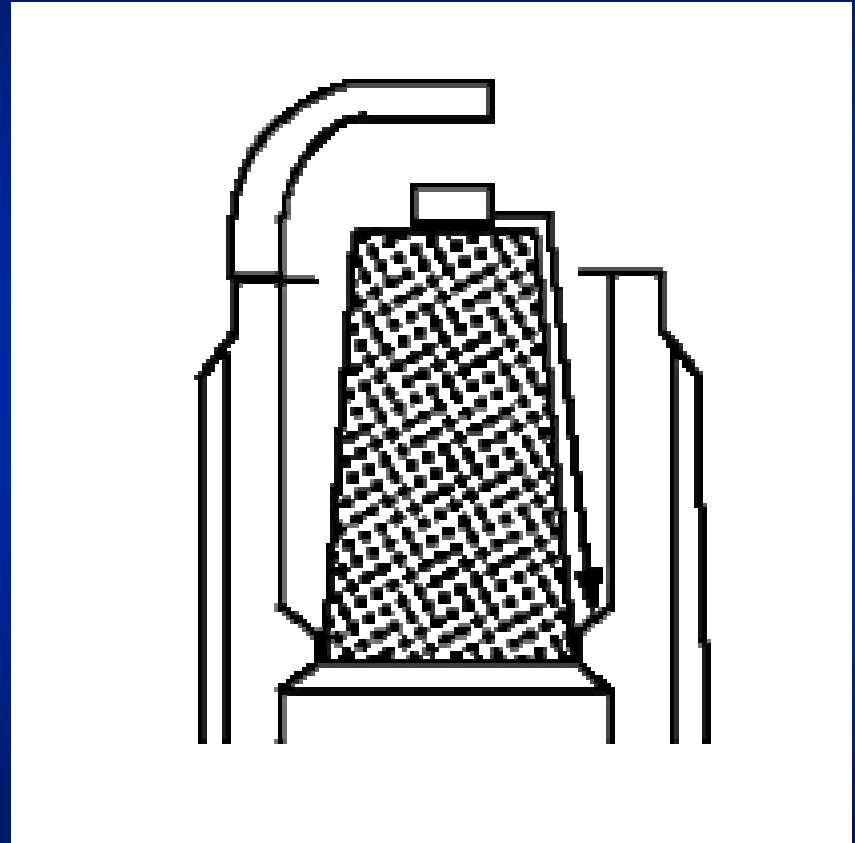



# Estados de la Bujía Según su Apariencia

- Hay tres criterios básicos para juzgar dicha apariencia: **Buena, Sucia y Sobrecalentada.**
- La apariencia de la punta de encendido también depende de la temperatura en la punta de la Bujía



## Buena

Ha funcionado en su zona óptima de trabajo, entre 450° y 850°C, también llamada temperatura de auto-limpieza.



# Estados de la Bujía Según su Apariencia

## Sucia

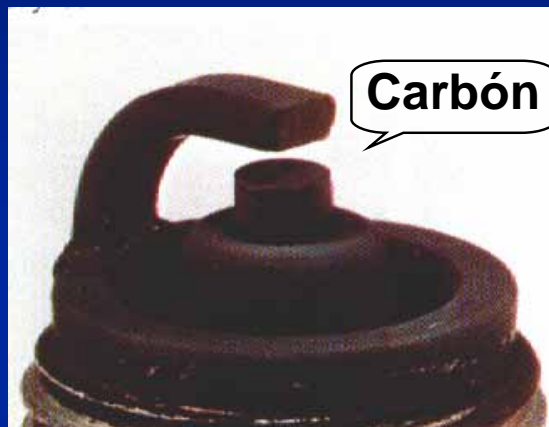

Carbón

No ha superado los 450° C

La corriente se fuga a través del carbón. El aislador se muestra recubierto de carbonilla o aceite.

Causas posibles:

- Bujía demasiado fría.
- Carburación Rica. Starter, Carburador o Inyección.
- Conexión defectuosa de cables de alta tensión.
- Demasiados días conduciendo al ralentí o en caravana....



Aceite

Suciedad → Falla el encendido



# Estados de la Bujía Según su Apariencia



## Sobrecalentada

Ha excedido los 850° C



sedimentos moteados

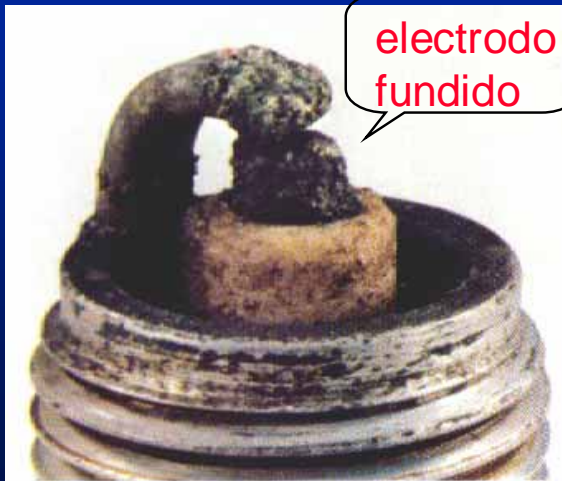

electrodo fundido

Muestran una superficie del aislador blanca con sedimentos moteados, o el electrodo fundido.

Causas posibles:

- Bujía demasiado caliente.
- Apriete insuficiente de la bujía.
- Encendido demasiado adelantado.
- Carburación Pobre.
- Lubricación / Refrigeración pobre.

Sobrecalentamiento → Preignición

# Bujía tipo Resistencia

- Incorpora una resistencia cerámica de 5 k ohm.
- Evita el funcionamiento incorrecto de los sistemas electrónicos del vehículo.
  - Inyección...
  - Encendido...
  - ABS...
  - Airbag...
- Incorporan la letra R antes del código de grado térmico Ej.: BP6ES → BPR6ES

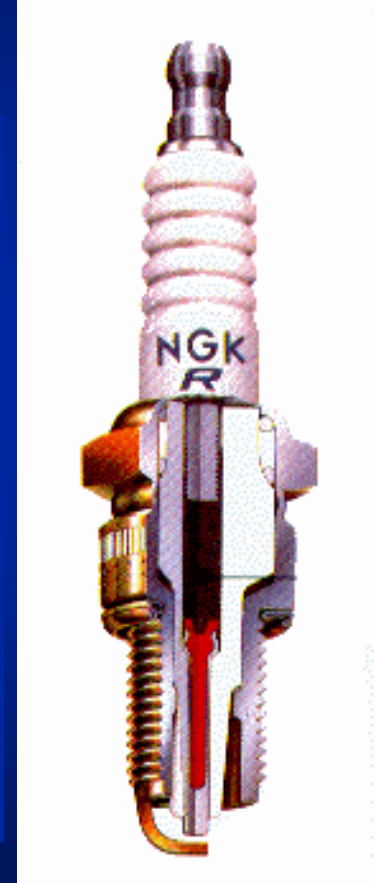

# Efecto Corona



Es el resultado de partículas de aceite en suspensión que se adhieren a la superficie del aislador por efecto del alto voltaje.

Esta condición no afecta a la bujía.



# Ranuras del Aislador



Para evitar que el alto voltaje tienda a fugarse a lo largo de la superficie del aislador, se incorporan ranuras como parte de este. Dichas ranuras extienden la distancia asegurando el aislamiento.

## ■ Voltaje de resistencia a descargas eléctricas

	Voltaje de resistencia a descargas eléctricas (KV)				
	15	20	25	30	35
Con cinco ranuras	[Bar chart showing resistance up to 30 KV]				
Sin ranuras	[Bar chart showing resistance up to 20 KV]				



# Nuevas Tecnologías



# TENDENCIAS



## PASADO

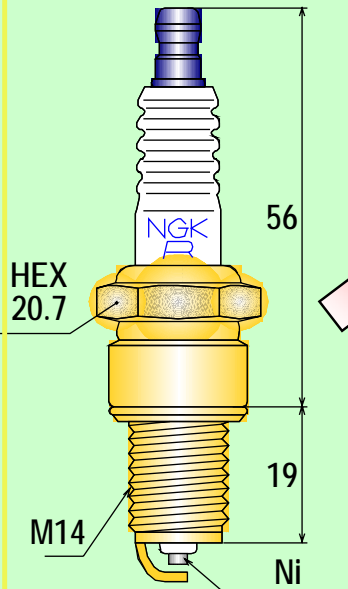

## PRESENTE

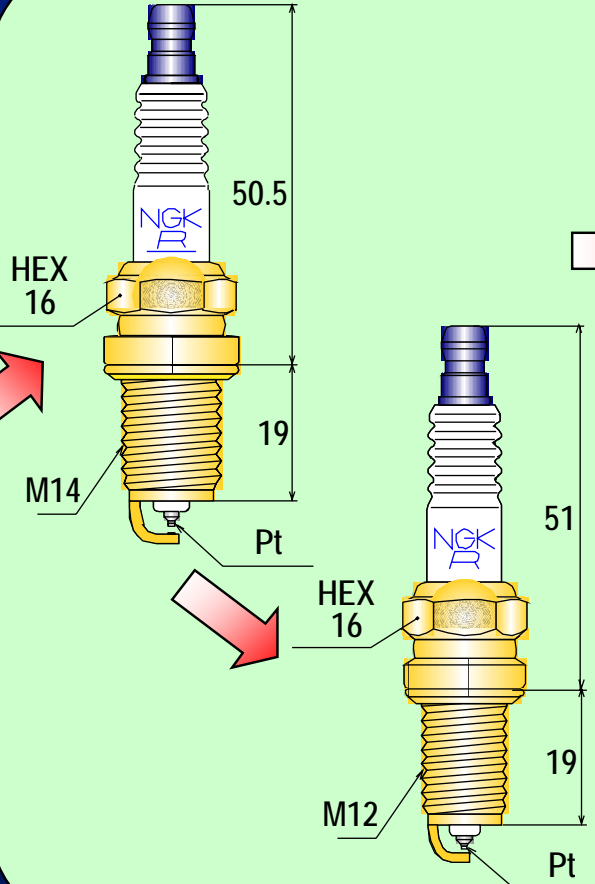

## FUTURO

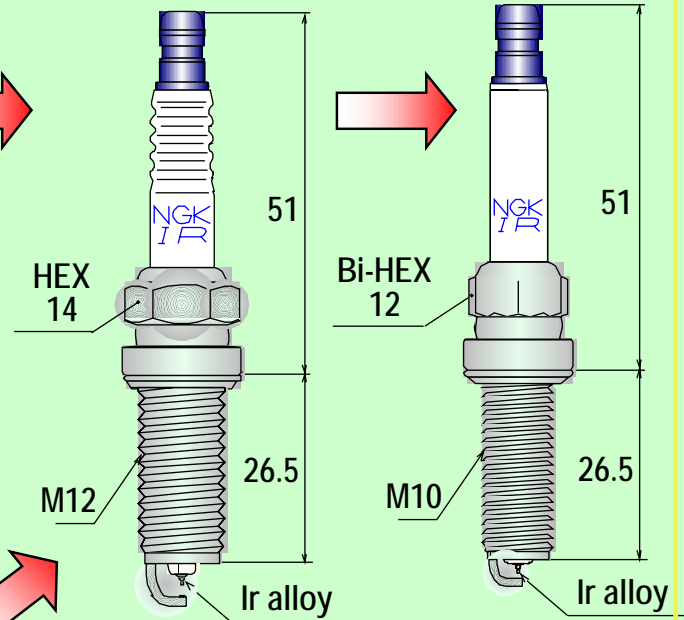



# Tendencia en diseño avanzado de motores

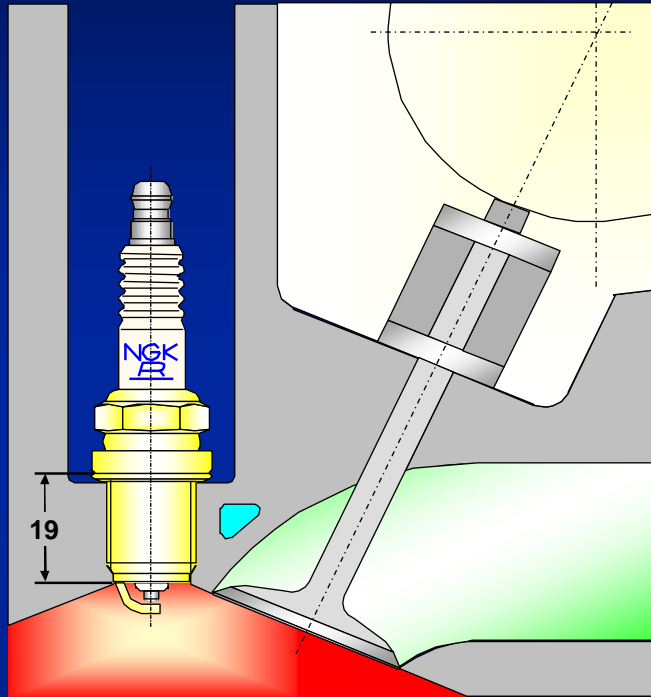

**PRESENTE**

**Ø 14 mm**

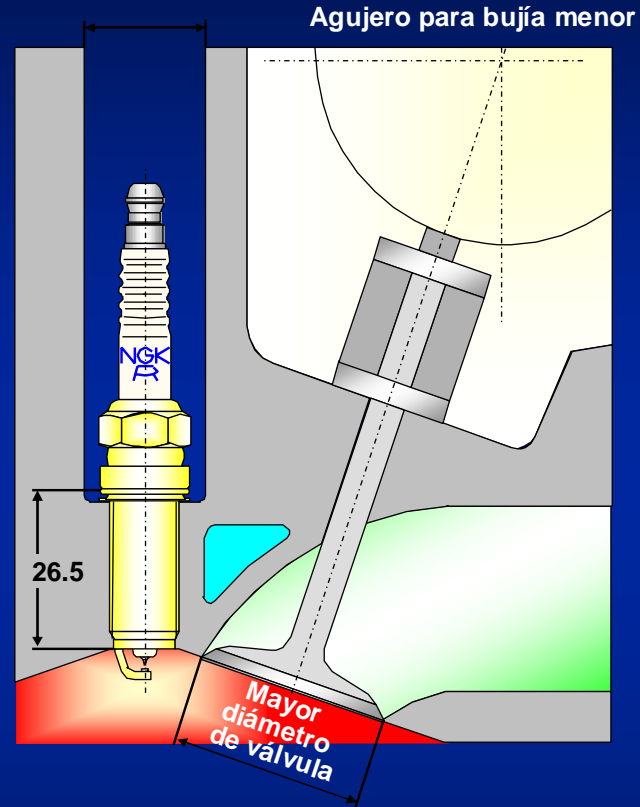

**FUTURO**

**Ø 10-12 mm**



# Puntas de Encendido



## Tipo Standard

Ej. BP6ES



## Punta de Platino (VX)

Ej. BKR6EVX



## Ranurado en V (V-Line)

Ej. BP6E





# Bujías Acanaladas en V



En USA llamadas **NGK V-Power**

**V-LINE SPARK** OFRECEN VENTAJAS EN TODOS LOS ASPECTOS

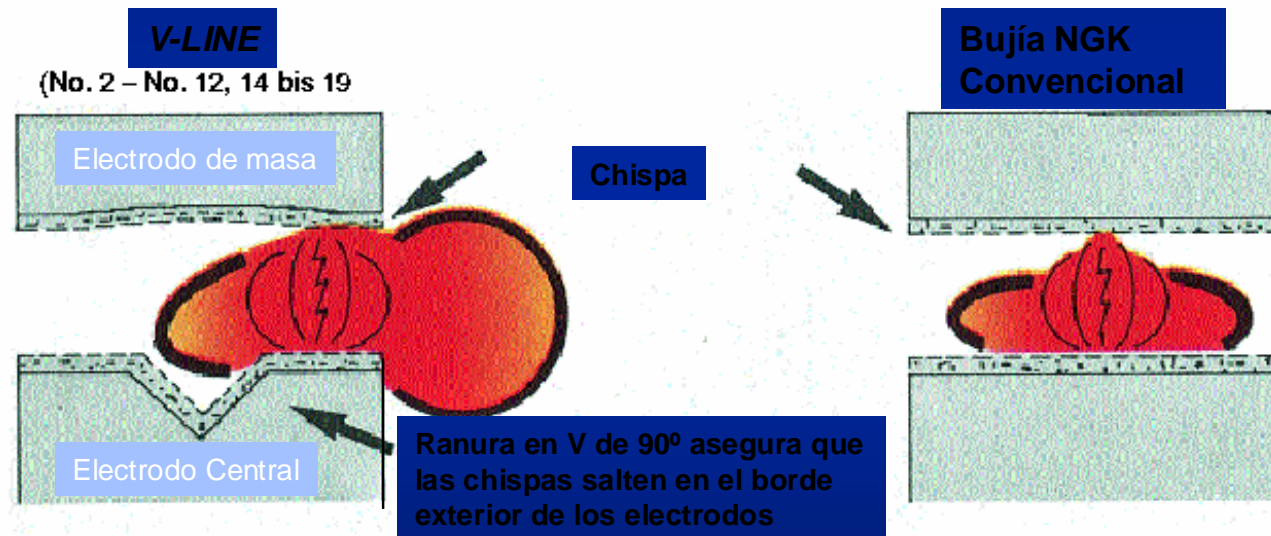

- El núcleo de la llama se origina cerca del perímetro de los electrodos y crece...
- Mejora la capacidad de encendido a través de un mejor arranque, ralentí y aceleración, influyendo en una mayor economía de combustible y protección del catalizador...



# Bujías Tipos Platino e Iridio V, VX, IX



- El diámetro del Electrodo Central es muy Pequeño
- Produce Chispas con Facilidad y su Capacidad de Encendido es Excelente.
- Se Obtiene una Mejor Aceleración, Arranque, Ralentí, Consumo...

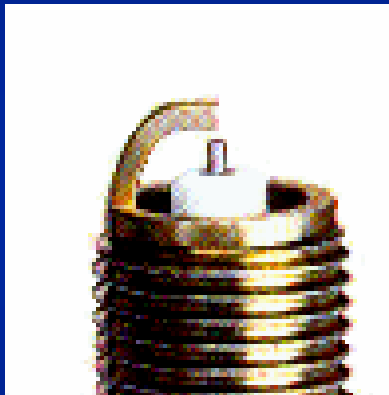

## Tipo V

Punta Fina en Oro / Paladio  
(Para Todo Tipo de Gasolina)

BP6ES → BP6EV

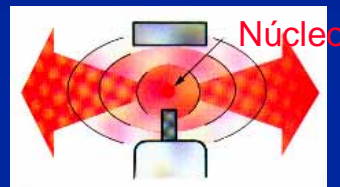

## Tipo VX

Punta Fina en Platino  
(Para Gasolina sin Plomo)

BPR6ES → BPR6EVX

Como el Electrodo Central es muy Fino el Núcleo de la Llama Crece...



# Bujías de Iridio







# Bujía Iridium IX



**Novedad**



**Las bujías de Iridio ofrecen el máximo poder de inflamación, bajas emisiones y mayor kilometraje que las bujías de platino.**



# Iridium - IX



Didier Auriol - Denis Graudet 206 WRC - Rally of Argentina 2001

Los campeones del mundo de rallyes y de Moto GP están equipados con bujías NGK de Iridio.



Comparación de ignibilidad entre una bujía vonvencional NGK y una bujía de Iridio NGK.



# Iridium - IX



El nuevo electrodo central tiene una punta de Iridio con solo 0.6mm de diámetro



Las descargas eléctricasse sitúan en la galga anular. Esto elimina los restos de carbonilla.

El resultado es un excelente arranque en frío.



# Iridium - IX



La ausencia de depósitos en la galga anular garantiza que el voltaje de encendido no se fuge.

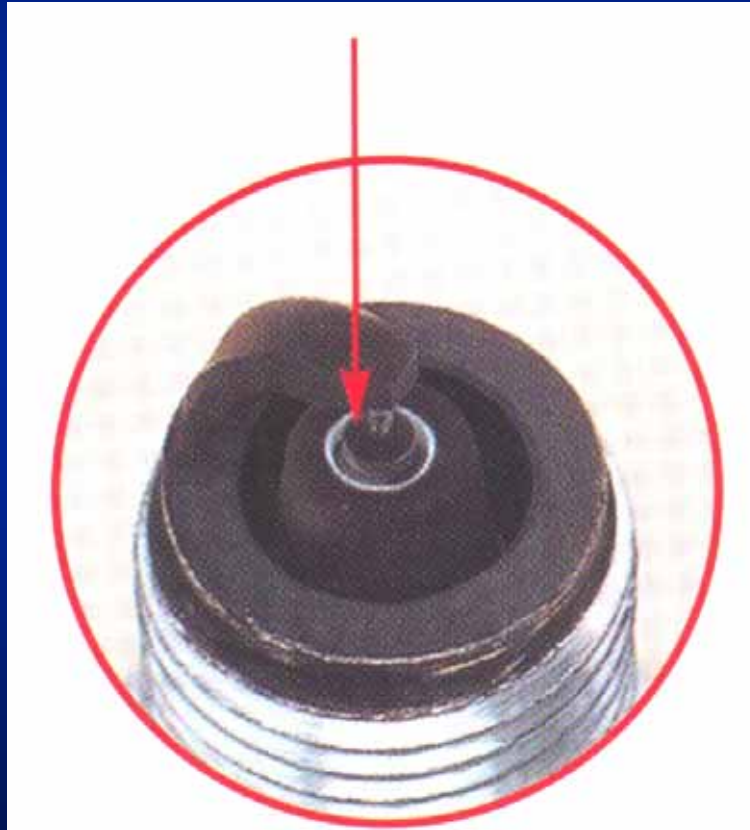



# Puntas de Encendido



**Tipo Galga  
Auxiliar**



Ej.: BUR6ET

**Tipo descarga  
Intermitente**



Ej.: BKR6EK

**Tipo descarga  
Semi-  
Superficial**



Ej.: BKR5EKU



# Tipo Galga Auxiliar

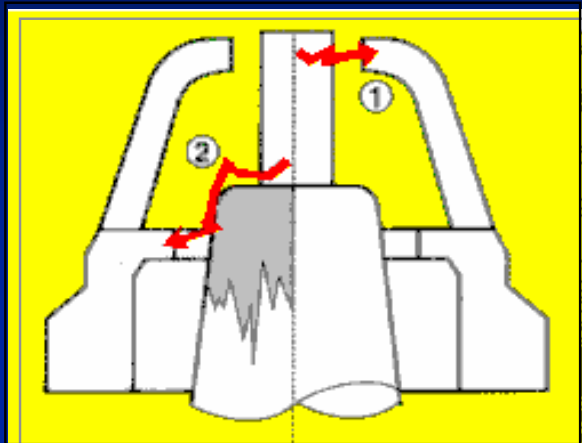

## Ejemplos:

BUR5ET	VW/AUDI 101 000 036 AB
BUR6ET	VW/AUDI 101 000 036 AA
BKUR5ET	VW/AUDI 101 000 033 AC
BKUR6ET	VW/AUDI 101 000 033 AF
BKUR6ET-10	VW/AUDI 101 000 033 AA

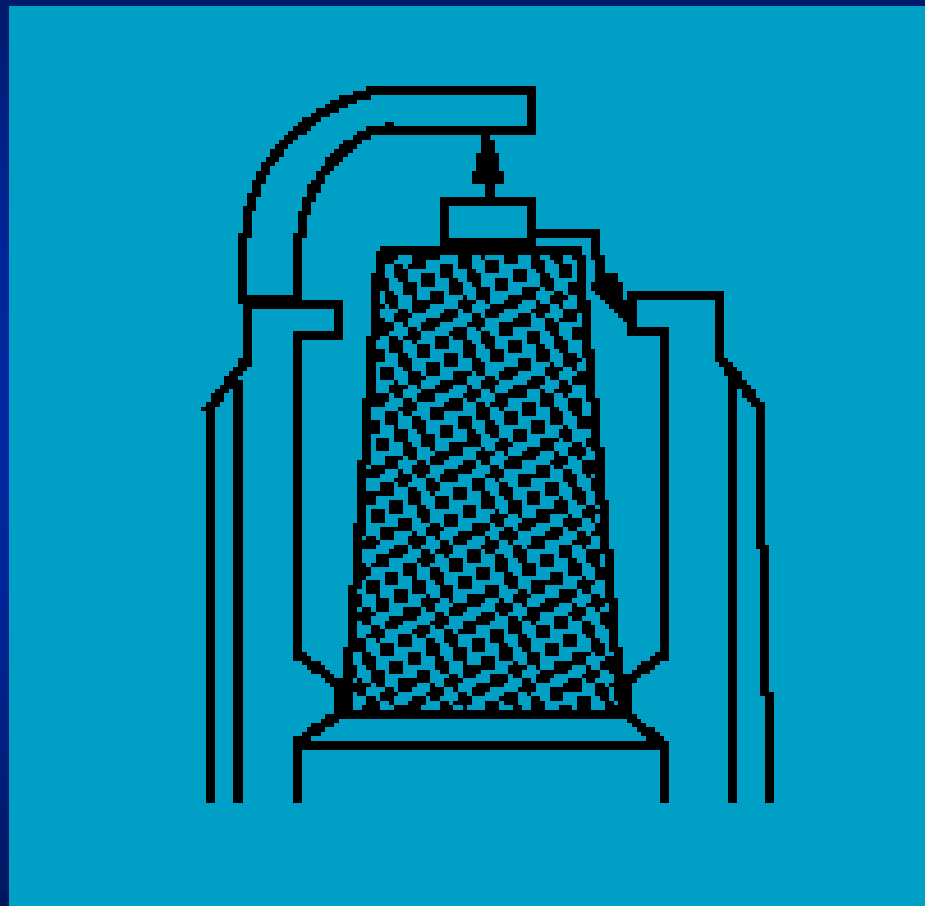



# Tipo Galga Auxiliar

Funcionamiento





# Descarga Intermitente



Descarga Eléctrica Normal

Descarga Eléctrica en caso de incrustaciones de carbón

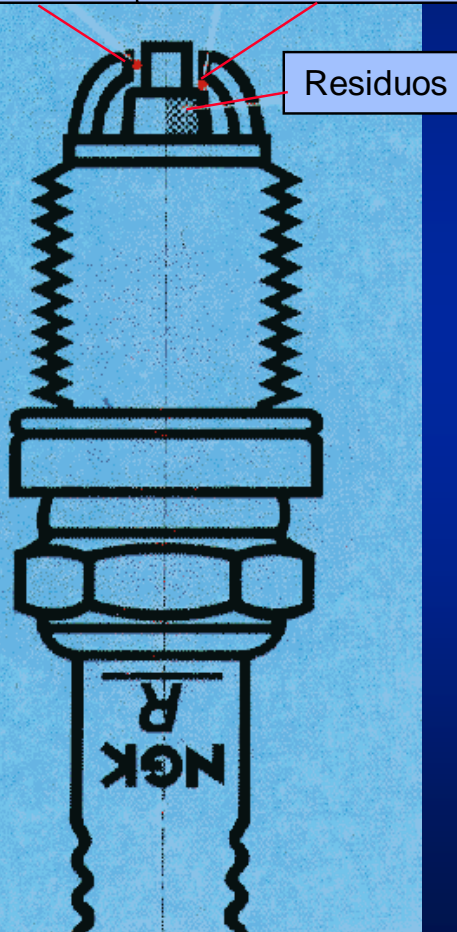

Ej...: **BKR5EK** Opel, PSA etc...  
**BKR6EK** BMW, Opel, PSA...





# Descarga Semi-superficial

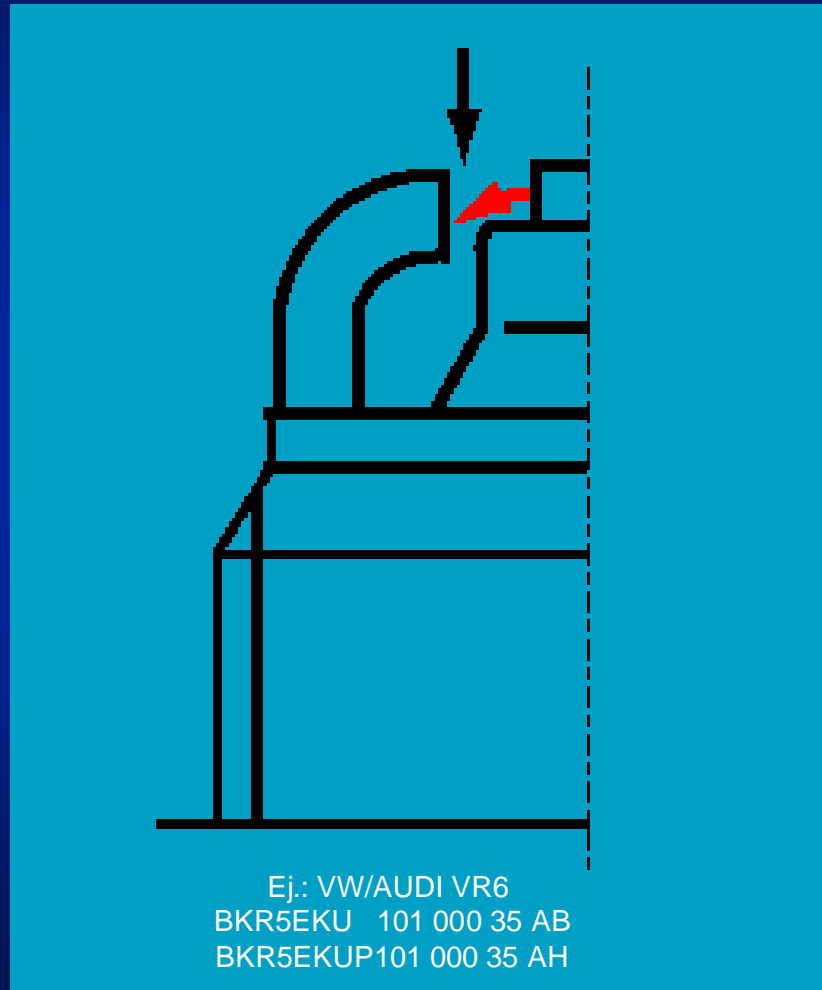



# Descarga Semi-Superficial



Funcionamiento





# Puntas de Encendido



**Platino en  
ambos  
Electrodos**



Ej.: PTR5A-13

**Motor  
Rotativo**



Ej.: BUR9EQ

**Competición**



Ej.: B9EGV

**Competición**



Ej.: R6252E-9



# Bujía de doble platino

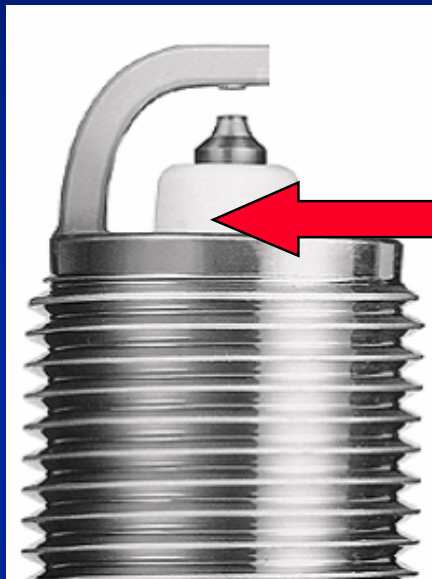

**VW Lupo**  
**60,000 km**



# Bujía de Iridio



**VW Phaeton: 60,000km**



# Bujía de Iridio



**DaimlerChrysler**  
**100,000 km**





# Bujía Híbrida



**Audi 2,0l FSI**



# Bujía Híbrida



**Audi 2,0l FSI**





# Montaje de la Bujía

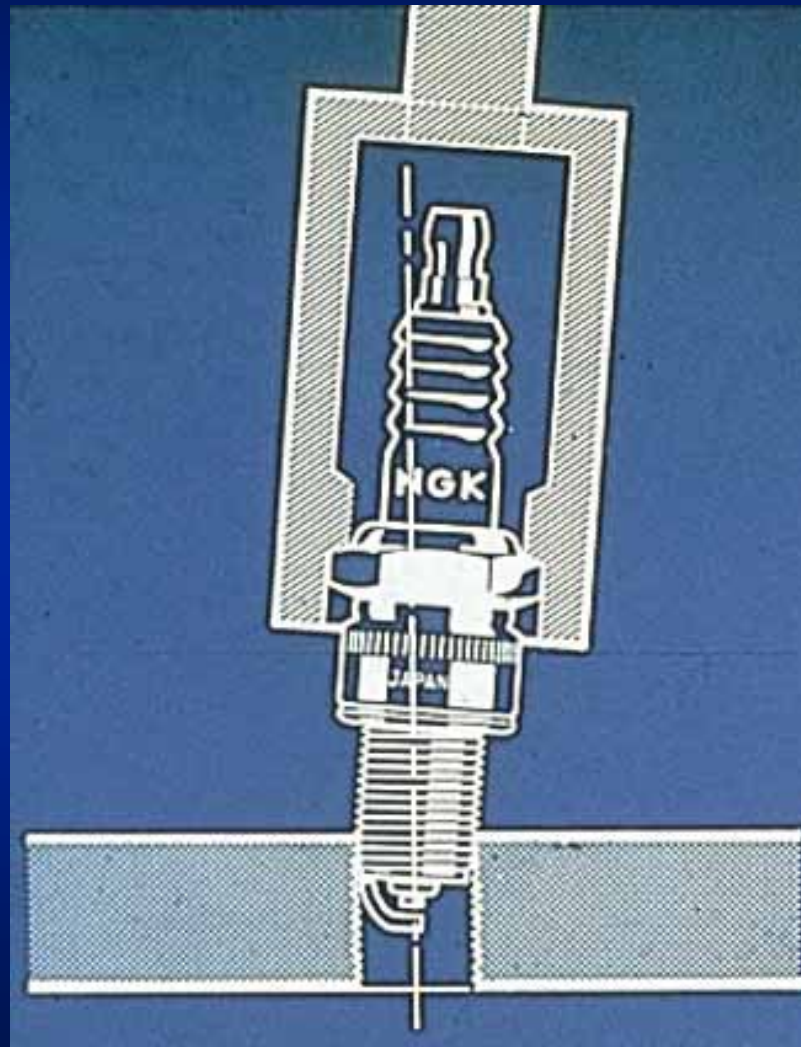



# Mal Montaje





# Apriete de la Bujía

